

LAMP 厚板対応スペーサー LAD-DP 型 取扱説明書

LAD-DP Spacer Installation Instructions

SUGATSUME スガツネ工業

❗ 『リフトアシストダンパー ストッパー付 LAD-ST型』との併用はできません。 Cannot be used together with 'LAD-ST'.

製品内容 Parts List

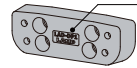

スペーサー：1個
Spacer: 1pc



バンド小ねじ：4本
Binding head screw: 4pcs
(M4×14)



取扱説明書（本書）：1枚
Installation manual: 1pc



バンドタッピンねじ：4本
Bind tapping screw: 4pcs
(4.0×20)

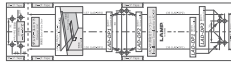

LAD-DP用取付テンプレート：1枚
Installation template
for LAD-DP: 1pc

	対応板厚 Door Thickness
LAD-DP1	25 ~ 35 mm
LAD-DP2	30 ~ 40 mm

取付寸法図 Installation Drawing

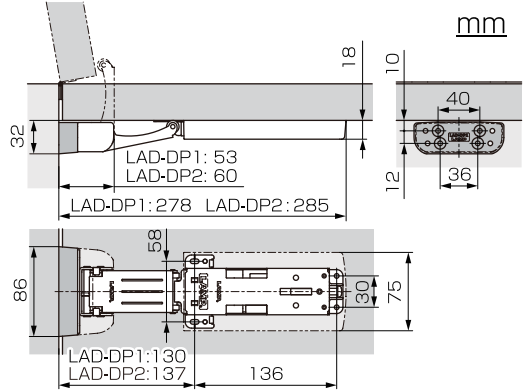

取付手順 Installation Procedure

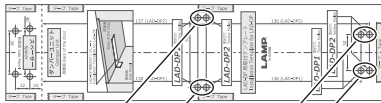
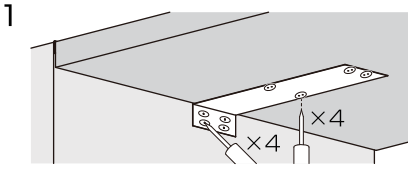

* LAD-DP1 と LAD-DP2 で使用する穴が異なります。
* Note that the installation holes are different between LAD-DP1 and LAD-DP2.

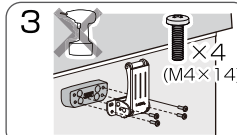
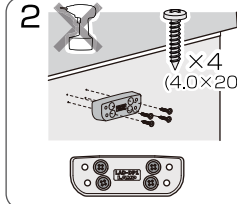

4 LAD 本体付属
Included in the LAD body
(4.0×16)

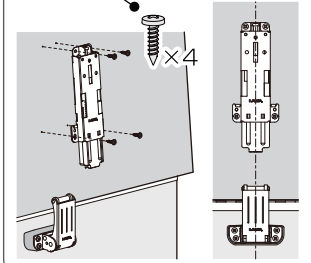

LAD-BKT 型 (別売) と併用する場合 When using together with LAD-BKT

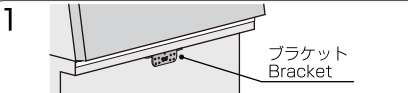

LAD-BKT 型 取扱説明書を参考にブラケットを取付けます。
Refer to the installation manual for LAD-BKT before installing the bracket.

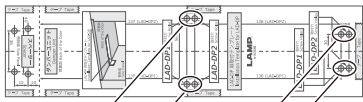
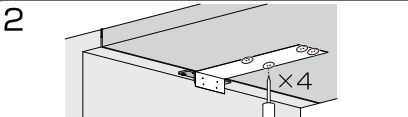

* LAD-DP1 と LAD-DP2 で使用する穴が異なります。
* Note that the installation holes are different between LAD-DP1 and LAD-DP2.

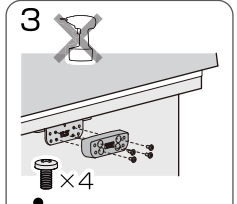

LAD-BKT 型 付属
Included in LAD-BKT
(M4×8)

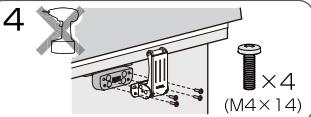

5 LAD 本体付属
Included in the LAD body
(4.0×16)

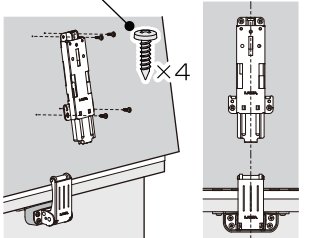

速度調整、カバーの取付手順、取扱上のご注意 及び お問い合わせ先は、『LAD リフトアシストダンパー 取扱説明書』をご覧ください。

As for Speed Adjustment, Installation of Cover, Safety precautions, or Contact Information, refer to the Instruction for LAD Lift Assist Damper, 2023.03 0843-3